

SMDS-75



Three Phase Rectifier Module



Type	V_{RSM}	V_{RRM}
SMDS-75-04	500	400
SMDS-75-06	700	600
SMDS-75-08	900	800
SMDS-75-12	1300	1200
SMDS-75-14	1500	1400
SMDS-75-16	1700	1600
SMDS-75-18	1900	1800

Type	I_{DAV}	T_c	I_{FSM}	i^2t	V_{TM}	I_{FM}	V_{TO}	r_T	T_{VJ}	V_{isol}	R_{thJC}
	A	$^{\circ}C$	KA	KA^2s	V	A	V	$m\Omega$	$^{\circ}C$	V	K/W
SMDS-75	75	100	0.75	2.8	1.6	150	0.8	5	150	3000	0.183

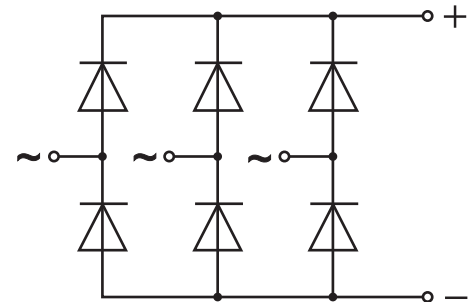
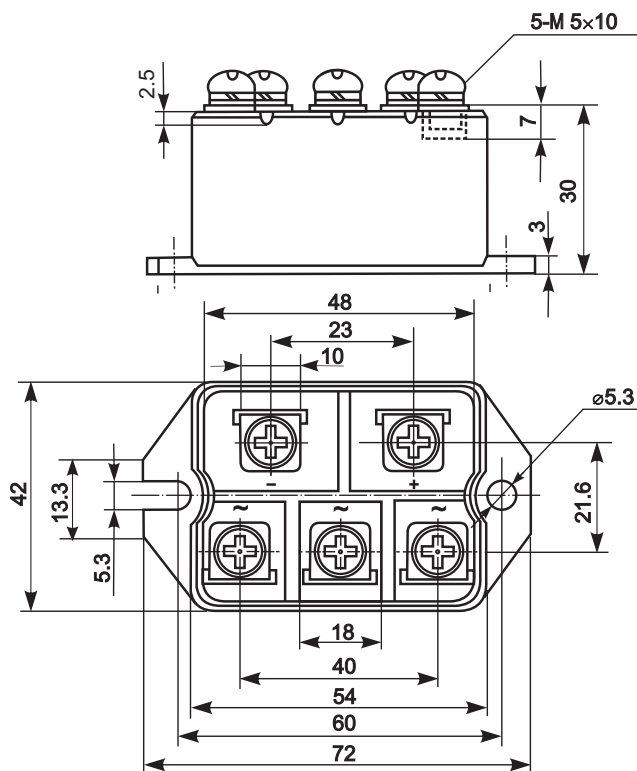

Features:

- Industrial standard package
- Heat transfer through aluminium nitride ceramic isolated metal baseplate
- Precise internal pressure contacts for high reliability
- 3000V RMS isolation voltage

Typical Applications:

- DC power supply for instrument and equipment
- Power converters
- Electronic welders
- Lighting control